



# NOVIOMAGUS MINI MILL

*PRODUCES HIGH QUALITY BONE GRAFTS*



## HIGH QUALITY CONSTRUCTION

The Noviomagus Mini Mill is completely reusable and facilitates easy cleaning due to its rounded corners, no crevices and its unique design. The Noviomagus Mini Mill consists of a housing, push block, handle, screw nut, funnel, clamp, sterilization tray and a set of three different sizes of milling drums.

Most parts of the Noviomagus Mini Mill are made of stainless steel, making it an extremely robust and durable appliance. Additionally, the milling drums are made of hardened stainless steel to minimize wear. The Noviomagus Mini Mill produces the following bone chip sizes, depending on the milling drum size:

- Extra Extra Extra Fine: 0.5 - 1 mm
- Extra Extra Fine: 1 - 3 mm
- Extra Fine: 3 - 5 mm

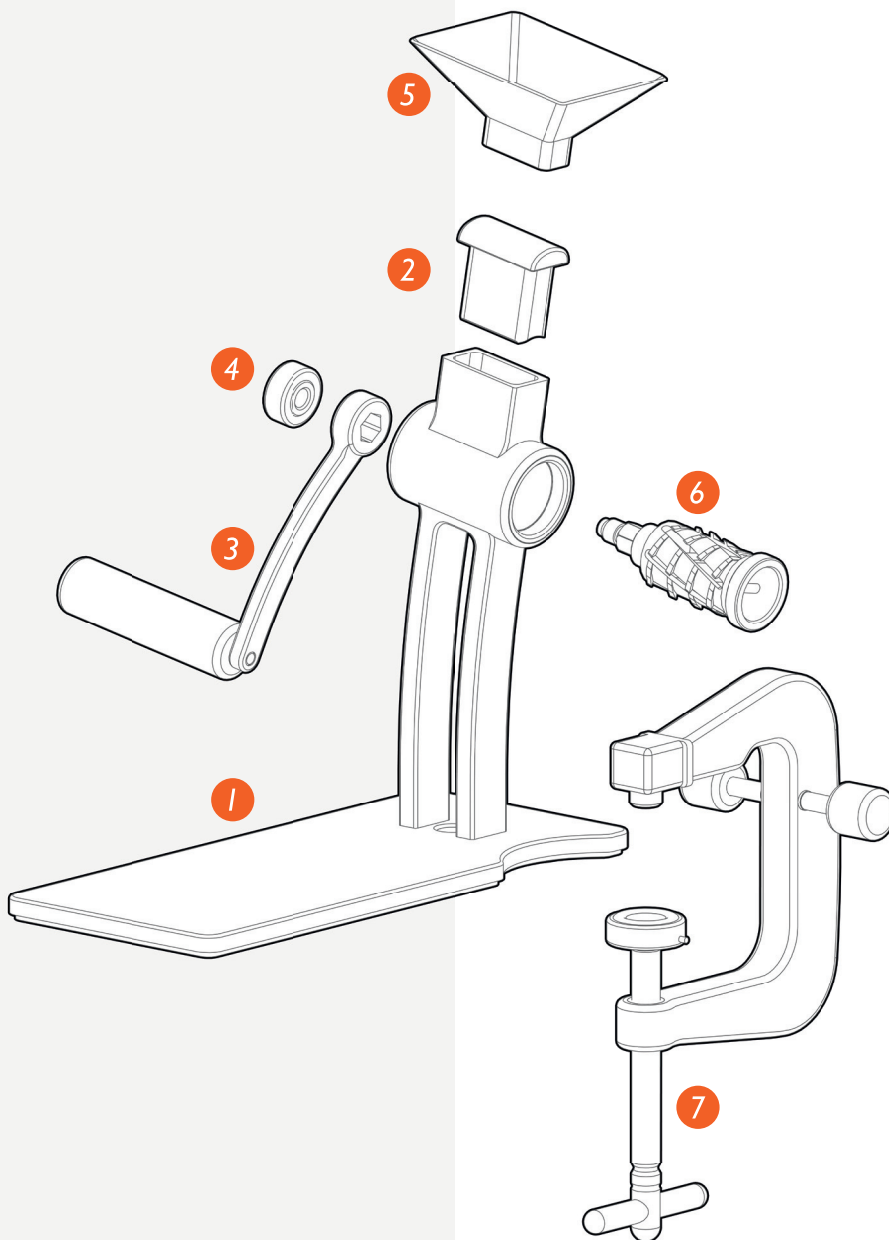

- 1 Housing
- 2 Push Block
- 3 Handle
- 4 Screw Nut
- 5 Funnel
- 6 Milling Drum
- 7 Clamp

## EFFICIENT AND FAST

The teeth of the milling drums feature a unique, patented technology. They are spirally positioned and razor sharp. Processing bone material with the Noviomagus Mini Mill requires little effort. The stable base plate and optional clamp makes the Noviomagus Mini Mill easy to use.

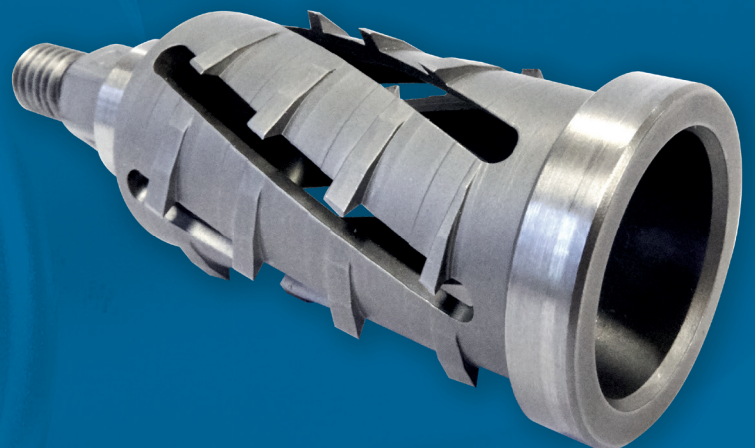

*Spirally positioned teeth*





## ADVANCED BENEFITS

- Three years warranty for hospital use.
- Three milling drums for different surgical application:
  - Extra Extra Extra Fine: 0.5 - 1 mm
  - Extra Extra Fine: 1 - 3 mm
  - Extra Fine: 3 - 5 mm
- Long lifespan with minimal wear of milling drums.
- Easy to clean and autoclavable.
- Optional detachable clamp for additional stability

## HIGH QUALITY GRAFTS

The Noviomagus Mini Mill produces bone grafts with intact trabecular structure, as it breaks out chips rather than scraping off bone. The Noviomagus Mini Mill can be used to process bone harvested from different areas such as the iliac crest,

jaw and spine. The grafts can be used immediately during surgery.

The Extra Extra Extra Fine milling drum produces bone grafts for cranio- and maxillofacial and micro surgery. The Extra Extra Fine and Extra Fine milling drum produces bone grafts for spinal and hand-foot surgery.



# ORDERING INFORMATION

## NOVIOMAGUS MINI MILL

Mini Housing	SBM-1002-29
Mini Push Block	SBM-1002-30
Mini Handle	SBM-1002-31
Mini Screw Nut	SBM-1002-32
Mini Funnel	SBM-1407-67
Mini Clamp	SBM-1012-37
Mini Milling Drum Extra Extra Extra Fine	SBM-1002-33
Mini Milling Drum Extra Extra Fine	SBM-1002-35
Mini Milling Drum Extra Fine	SBM-1002-34
Sterilization Tray Mini Mill	SBM-1002-36

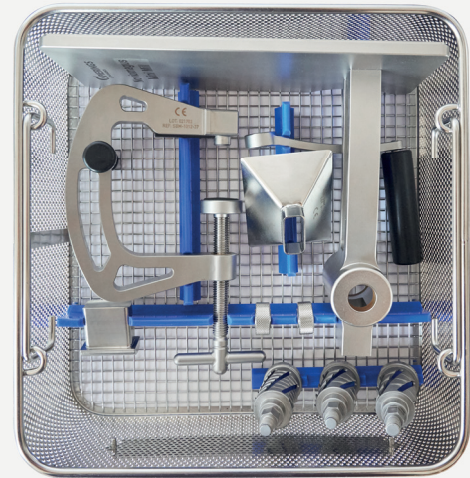

STERILIZATION TRAY MINI MILL

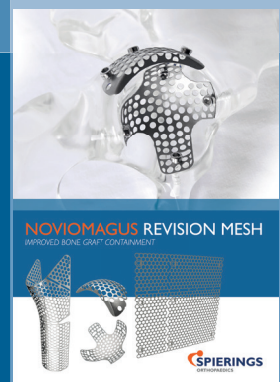
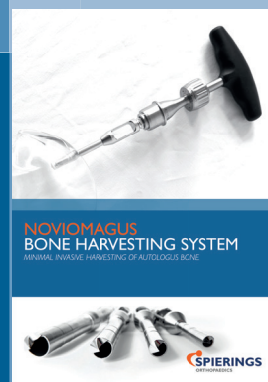
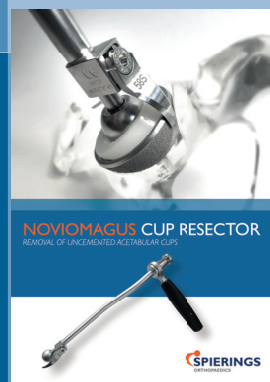
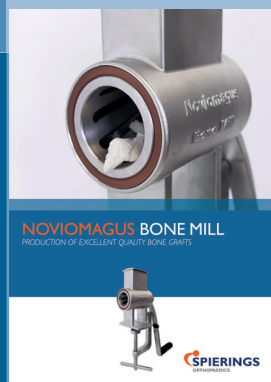
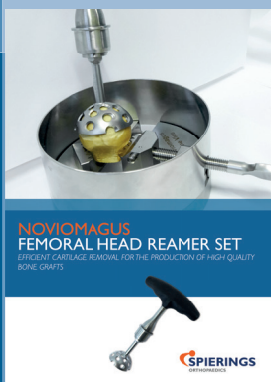

The Noviomagus Mini Mill is CE-marked and FDA approved. US-Patent No. 6,318,651. No rights can be derived from the information in this brochure. Other Noviomagus products manufactured by Spierings Orthopaedics B.V. are: Noviomagus Femoral Head Reamer Set, Noviomagus Bone Mill, Noviomagus Cup Resector, Noviomagus Bone Harvesting System and Noviomagus Revision Mesh.

BRO-SBM003-6 EN Printed in the Netherlands ©2024 Spierings Orthopaedics B.V.

**Manufactured by:**  
**Spierings Orthopaedics B.V.**

Berg en Dalseweg 199  
6522 BJ Nijmegen  
The Netherlands

T +31 (0)24 350 16 03

E [info@spierings.biz](mailto:info@spierings.biz)

I [www.spierings.biz](http://www.spierings.biz)

  
**SPIERINGS**  
Orthopaedics